

- 1 Maxiflow 1200 - Male Headwall
- 1 Maxiflow 1200 - Female Headwall

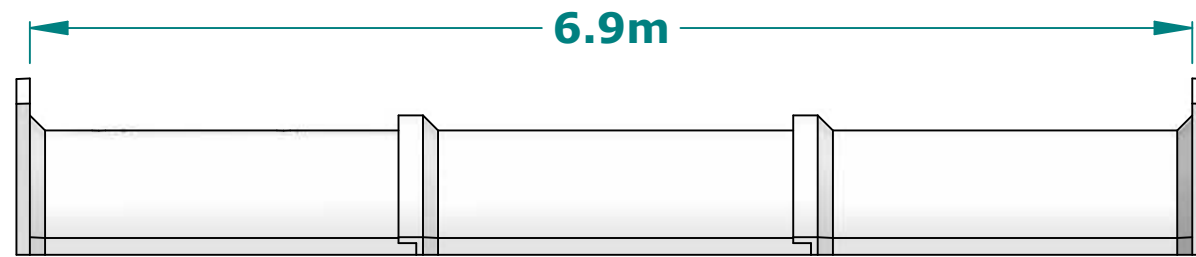

- 1 Maxiflow 1200 - Male Headwall
- 1 Maxiflow 1200 - Centre - Female - Male
- 1 Maxiflow 1200 - Female Headwall

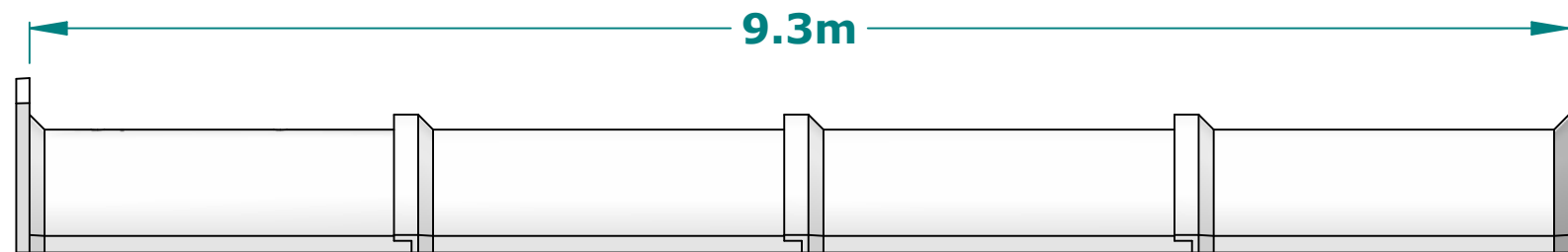

- 1 Maxiflow 1200 - Male Headwall
- 2 Maxiflow 1200 - Centre - Female - Male
- 1 Maxiflow 1200 - Female Headwall

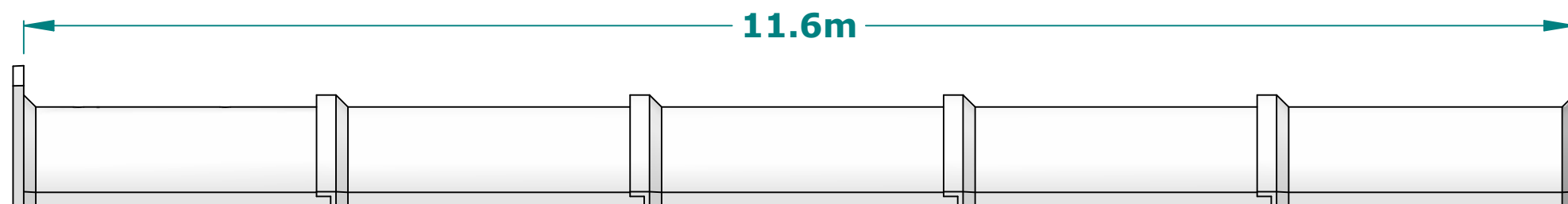

- 1 Maxiflow 1200 - Male Headwall
- 3 Maxiflow 1200 - Centre - Female - Male
- 1 Maxiflow 1200 - Female Headwall

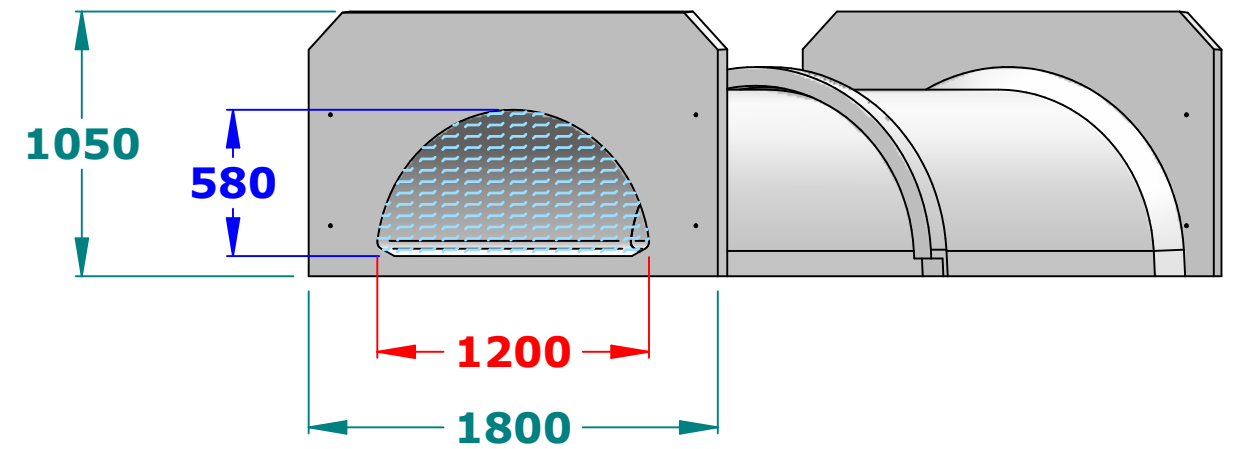

Maxiflow 1200 - 2 Piece Crossing
General arrangement

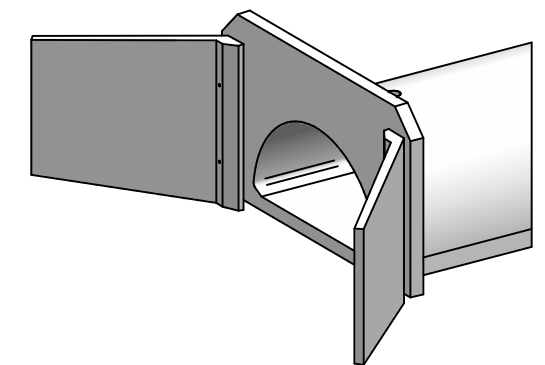

- Erosion control wings are available and recommended in all applications.
- Longer crossings are available on request.

Maxiflow 1200 - Crossings

© Padman Stops. This document is and shall remain the property of Padman Stops. Unauthorised use of this document in any form is prohibited. Patents may apply.

All dimensions in millimetres unless otherwise stated.

info@padmanstops.com.au
tel. 03 5874 5282

