

The dimension in green gives the distance from the top of the PE 900 bubbler to the top of the pipe.

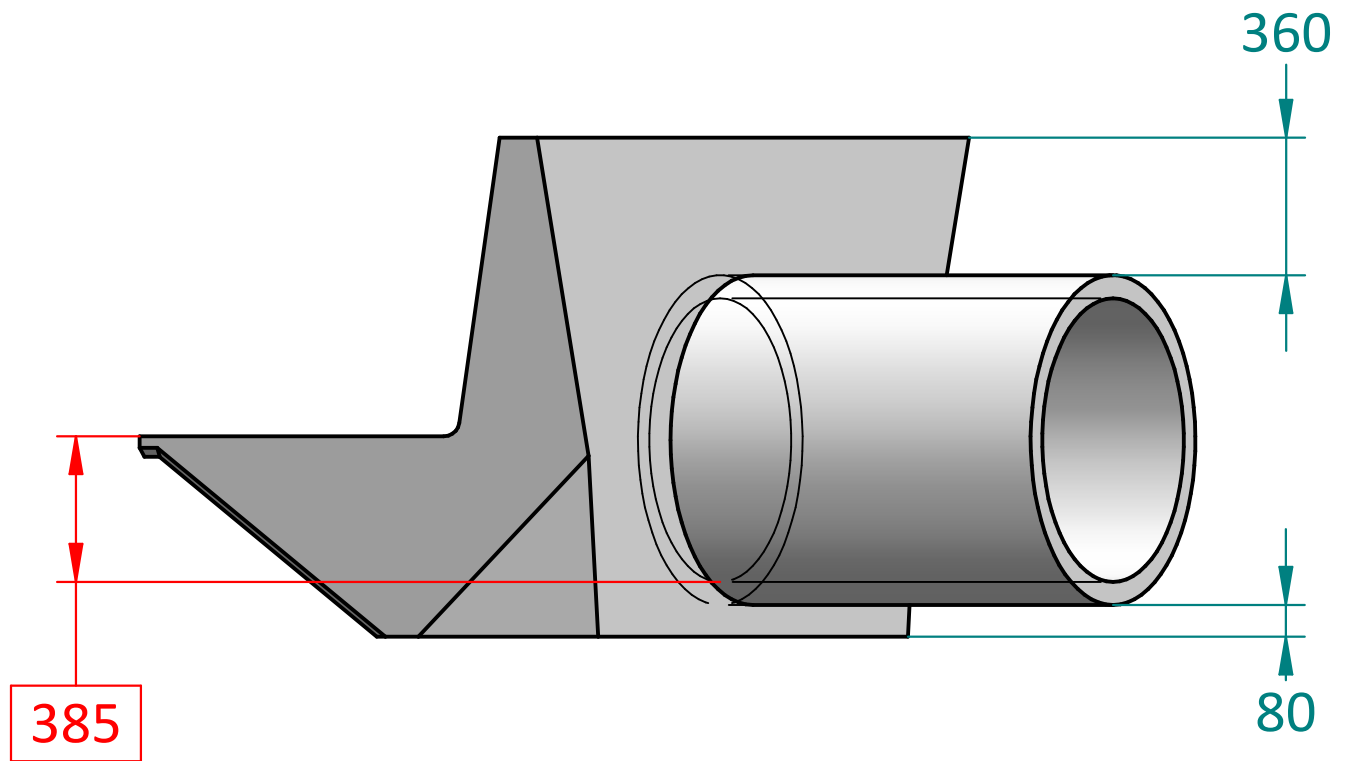

The dimension in red gives the distance from the PE 900 bubbler sill level to the INVERT of the pipe.

Customer approval sign :

Approval date :

PE 900 bubbler w 750 (30C) pipe

© Padman Stops. This document is and shall remain the property of Padman Stops. Unauthorised use of this document in any form is prohibited. Patents may apply.

Dimensions in mm.
unless otherwise stated.

info@padmanstops.com.au
tel. 03 5874 5282

Padman Stops

Innovative Irrigation Solutions

